Usage of 3D Computer Modelling in Learning Engineering Graphics

Zorana Jeli, Branislav Popokostantinovic and
Misa Stojicevic

Additional information is available at the end of the chapter

<http://dx.doi.org/10.5772/65217>

Abstract

What is graphic communication? Firstly, it is a very effective way of communication between the technical idea and the final solution of the problem in engineering. The process engineering design (design) begins with visualization, i.e., reviewing the problem and possible solutions. Then, sketching leads to the preparation of the initial idea. Next step is preparation of geometric models, which are used for a variety of engineering analysis and, finally, creating detailed drawings and/or 3D models, which are used for the production process. Visualization, sketching, modelling and preparation of technical documentation are ways in which engineers and technologists communicate in creating new products and structures in the modern technical world. Essentially, graphic communication, which is done via engineering drawings and models, is the clean, practical language with defined rules that need to be overcome if one wants to be successful in engineering design (any kind of design). When that language can overcome any approach to solving engineering problems. Ninety-two percent of the engineering design process is based on the graphic display. The remaining 8% is divided between the mathematical calculations and written and oral communication. Fifty percent of the projecting time a designer spends on are purely visual and graphic activities. We like precision in communication. Engineers use graphical tools, some of which are centuries old and are used day-to-day, while others are very new and conditioned by the rapid development of computer technology, such as Computer Aided Design (CAD) systems. From this chapter, users will be able to familiarize themselves with the above tools and principles of their use.

Keywords: graphics communication, freehand sketching technical drawings, 3D model, 3D modeling, communication process

1. Introduction

Three-dimensional modelling is a modern approach to the development of technical graphics systems. Engineering graphics and 3D solid modelling, the two basic methods of design underrepresented in use today, are shown in **Figure 1**. The engineering graphics in the form of multipurpose technical drawings (top left) is a method of design that is used for almost two centuries. Modern design methodology tends to the greater representation of computer technology, and the design process is focused on the preparation, analysis and construction of three-dimensional geometric model (bottom right). Although shaded, display model on the screen looks impressive, but the real power of this method is precise and unambiguous description of the object that contains all the data stored in the computer. During the process of preparing a given work, all the data are stored in memory of the computer and can be used by other customers in the supply chain, for example, preparation for engineering, manufacturing, analysis, documentation and manufacturing drawings.

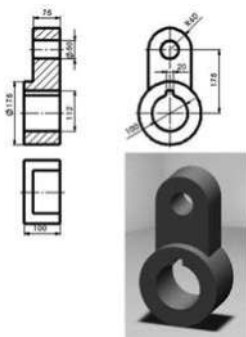

Figure 1. Technical drawing and 3D solid model.

Modern development of technical systems cannot be possible without the use of this type of graphic expression. A detailed description of the methods and principles of 3D modelling is given below.

2. Engineering graphic communications

Communication between people takes place polyvalent: through language, written text, symbols or graphics, or people say, write or draw.

Many primitive societies have not progressed to the level of the permanent record. All communications in much of the history were conducted orally. Oral expression is the first form of human communication with the environment. Children are taught voice expressing before the age of 2 years.

During training, acquire the ability to communicate in writing. Thus acquire the ability to read and write is the most widely used mode of communication. The skill of communication through symbols infiltrates in this area of communication fully.

The graphics are also very important form of communication. All graphic forms are very important for communication among engineers in all fields of technology.

Engineering graphics is the language used by engineers to transfer ideas and information needed for the construction of technical devices and systems. This language includes drawings, sketches, plans, schedules, diagrams, notes and instructions. Graphics in Engineering has three main objectives, namely:

- Analysis and display structures
- Transfer of information on the structure
- Record of the development and construction of replacement in it

Engineering graphics includes formal and informal drawings, sketches, all diagrams and plans, and sometimes non-physical relationships of ideas, if these relations can be graphically displayed.

Engineers are constantly using informal drawing or sketching—"talking pen and paper," and generally, this type of communication crossed without classical training. Throughout history, particularly in recent times, and resulting from technological advances in the field of computer graphics and computer, this type of communication is gaining in importance. The idea is given in the form of freehand sketching; a complete process projecting was carried out through computers and 3D software.

Engineering graphics is a bridge which ideas are translated into reality. It is hard to imagine a modern society without that, moreover, a large part of modern industry would not have occurred or would cease to exist.

3. Technical sketch

Sketching is the simplest form of engineering drawings. It is used to quickly develop ideas and transferred to others. Good sketch should contain three basic characteristics as: quickly prepared, simple and easy to interpret. Nothing is needed for sketching except a pen and paper. When performed without a prop called freehand sketching, polished and more formalized sketch station technical drawing, which is quite different and used for other purposes. It is important to distinguish between these two activities. Exercise should develop skills and techniques of sketching, and making of polished technical drawing if necessary. Otherwise, trimming the drawing would be a waste of precious time.

In addition to making it possible to convey the idea of another, sketching is a great method of communicating with itself. Sketch supports thinking can improve memory or to facilitate the

clarification of the spatial situation. The pencil and paper can be very useful during the development of physical or spatial concept (Figure 2).

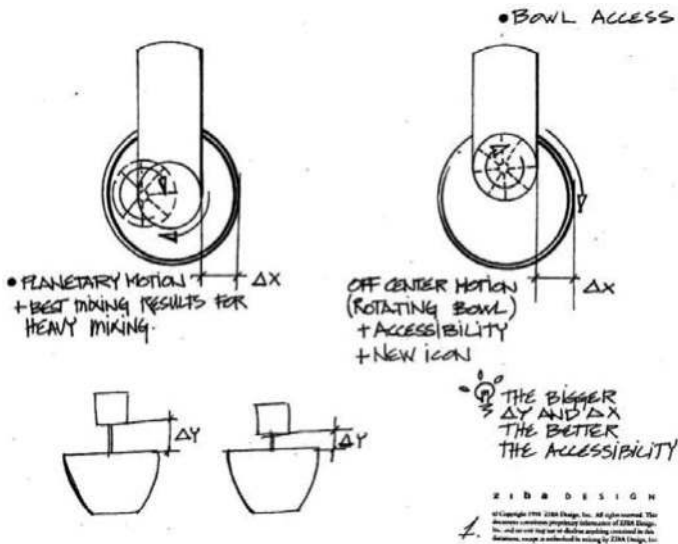

Figure 2. Technical sketches (Ziba design).

Freehand sketching is one of the oldest forms of, if not the oldest form of expression of engineering ideas. The knowledge that we gain from that field is used during the entire engineering work. This form of expression is resistant to the technological development of the system for technical drawing and graphic expression of technical systems. It exists and is not visible when the final time limit would cease to exist independently of the principles of graphic communication. An example of freehand sketching of mechanical part is shown in Figure 3.

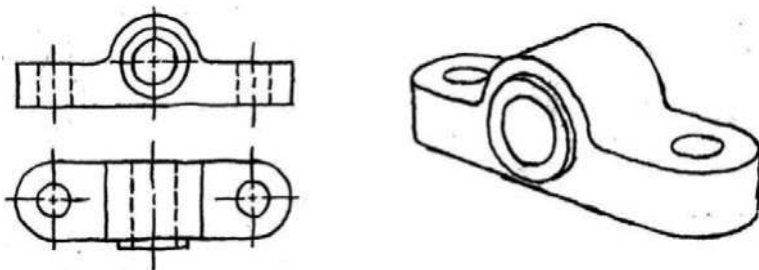

Figure 3. Sketch of 2D drawing and 3D model.

This fact has been proven in a number of leading world universities. The basic philosophy of the new approach graphic communications lies in the realization that modelling of the body serves as a starting point for the presentation of the technical system, visualization, stress analysis and production of parts, and finally to the formation of technical documentation. According to this philosophy of training, end-users must contain in itself the power freehand sketching was carried out in four stages:

1. Sketching, to facilitate mastery of 2D designing, which in turn present the basis for the design of a 3D model of the technical system.
2. Spatial sketching, which helps train for geometric modelling of the technical system on your computer.
3. Sketching projection with sections and dimensions in preparation of technical documentation based on 3D models.
4. Reconstruction of some parts of the technical system captures parts of the system, sketching and reversible technical documentation.

4. Technical drawings

Technical drawings are graphical representations on which they are made machines, structures, components and technical systems. They include:

- Detailed drawings, showing components, material of which should be made, their dimensions and other information (e.g. who designed, approved, when it was designed, etc.).
- Switchgear drawings, which show the manner in which the components are assembled.
- Spatial drawings or perspective view of a facility.

The process of communicating technical and scientific ideas and concepts implemented in such a way that leaves little room for error. This “language” contains a lot of generally accepted procedures, rules and methods, that users study and use.

Technical drawing is based on the principles of descriptive geometry, or the design for displaying spatial element in the level of drawings, all in combination with the regulations, which were formalized national and international standards to simplify, simplify, and to adapt the technique of this preview. Technical drawing is not artistic drawing and of itself is a special discipline that has its own logic, however, if such can be taught and learned.

5. Visualization cycle

A very powerful tool in the engineering and design work is the ability to imagine a solution to a problem. Visualization is the ability to form mental images some objects that are essentially

non-existent. Engineers and designers have a highly developed ability to plant a mental image, but also that the “control”, that is observed from various sides, changing shape, look inside, to move some of its parts and manipulate imaginary object.

For effective use of graphics as a tool for visualization of design ideas, it is necessary to understand the two-dimensional graphics, the user draws on paper or computer screen, and the display of visual information in another form. Previously, enumerated drawing techniques that may be used for this purpose, the user draws what sees, and this is a direct link between what is seen and what is displayed (**Figure 4**).

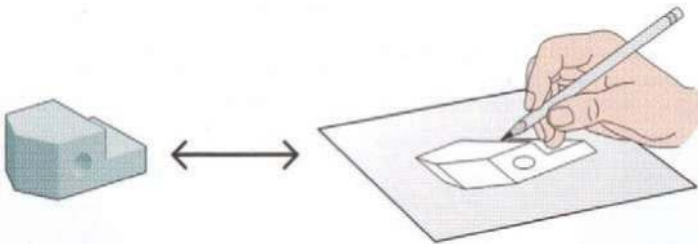

Figure 4. Interaction hand/eye [1].

Mind processes and interprets visual information and controls muscles that hold a pencil (**Figure 5**). As a 3D object, a drawing that is formed on the paper can be seen and serve to make organizations and focus the image in the mind of the user. Thus, creating a loop transfer form between the mind, the level/pencils and drawing, which allows realize the idea of 3D objects. In other words, the image in the mind can be formed without the aid of a real object. Now sketch an even more important role, because the real subject is not in the field of view (or perhaps even the idea) and the sketch becomes the sole record of the object. The eyes and the mind, seeing the sketch, can begin modification and development facility, new drawings can be made, and the whole cycle can be starting again. This is only visualization cycle.

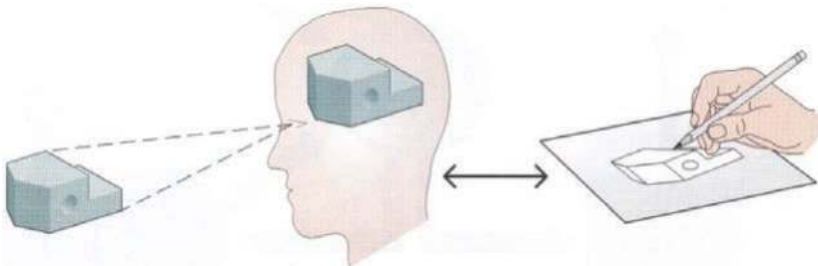

Figure 5. Interaction hand/eye/mind [1].

Visualization is an important and integral part of the engineering design process. Whether you are using a computer or a classic tool for technical drawing, engineers and technologists must have the ability to document their design ideas, on the basis of well-defined technical graphics standards. They must also have the ability to understand at a deep level, three-dimensional forms and their documentation.

The ability to visualize shapes in mind enhances the ability of users to understand how existing facilities, and facilities that have not yet been incurred. Visualization of three-dimensional shape allows the playing of the “what if” in the early stages of the design process, before forming the physical models. It also allows the ability to visualize and detailed spatial analysis of the occurrence of any problems.

Engineer or technologist should be professionally involved in solving the problem. For most problems, it is necessary to ask some basic questions:

- What information is available?
- If it comes to graphic information, in which form (planar drawing, photography, computer rendering, etc.)?
- What are the questions to be answered?
- Is there sufficient information (graphic or otherwise) to answer these questions?
- If there is not enough information, where to find them?

In most cases, there is not enough information. In this case, consult external sources or inventing new ideas. The information can also be generated from previous knowledge. For most of the problems with video information that is the best way. If there is not enough graphical information is necessary to immediately start drawing what is known. Now begins the game of “what if” in which everything has a mental picture, but there is large number of ideas that are difficult to keep in mind. They are at the paper (or computer) and moving idealization process of admission and the process of rapid generalized ideas that are developed in the mind.

How ideas are developed drawings are becoming more formal. The formality is necessary for communication with other users.

This process is very similar and in developing ideas into three-dimensional space. Tools are different, but the idea of the formation of the design is the same. When you gather all that is known about the mental construction and the result of drawing/modelling, it is possible to visualize a 3D object and continue to develop.

6. Graphical methods of technical systems modelling

Engineering design show [2] is a collection of tools that help designers and developers to visually project and spatially prepare preliminary designs, and also that these solutions are

checked and displayed to others. During the examination of designs, when a designer/developer combines, compares, processing and preparation of examination of all data and conceptual solutions mainly used freehand sketching tool.

Simplify, the development phase of this process involves defining ideas in two phases: research and development. In the development phase, the researcher translates your ideas from the research phase of the use of computer tools (or, as the case was before, when was in use graphic communication tools of engineering and technical drawings and the like.) in a final feasibility study, used to further communication in the framework of the preparation of the final product. In recent years, conceptual phase is mainly based on freehand sketch, a development on the application of a software tools and computer geometric modelling (Figure 6).

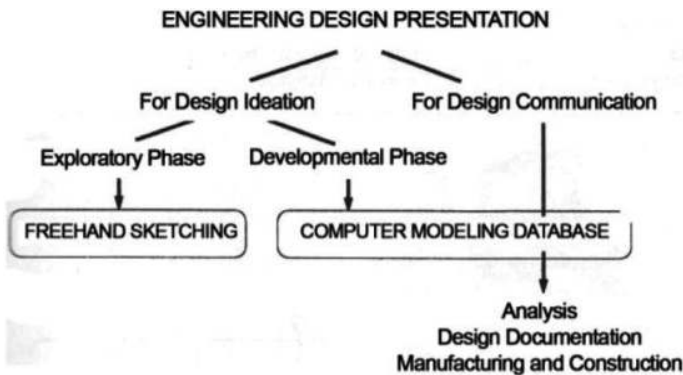

Figure 6. Engineering design presentations [2].

7. Modelling, models and technical systems

Modelling is the process of presenting abstract ideas, words and shapes, through the proper use of the simplified text and image [4]. Engineers use models for thinking, visual, communication, prediction, control and training. The models are classified into two categories: reality could be shown on the descriptive or predictive way.

Descriptive model represent abstract ideas, products or processes in a recognizable form. An example of a descriptive model can be the engineering drawing or a 3D computer model of the mechanical part (Figure 7). Drawing or model serves as a communication tool, but they cannot be used to predict the behaviour or performance obtaining technical elements/systems. The predictive model is one that can be used to understand and predict the behaviour/performance design solutions, products or processes. For example, predictive finite element model is a model Cantilever, which is used to predict the mechanical behaviour of the cantilever under the given loads.

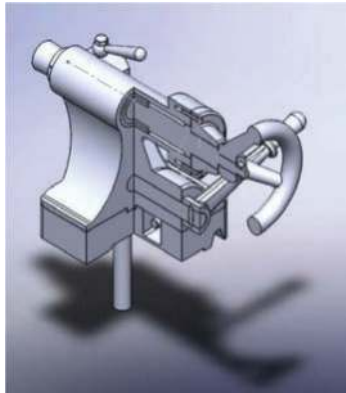

Figure 7. Descriptive model [5].

During the preparation of the final product, it is possible to use two types of models: mathematical models and physics models-layouts. The mathematical model is a set of mathematical equations that represent parts of the system. **Figure 8** is an example of the mathematical model used to predict the loss of power of thrust bearings while increasing speed.

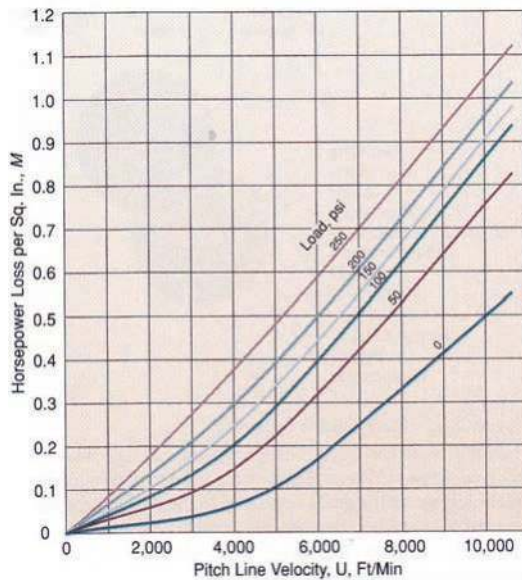

Figure 8. Predictive model (example of a mathematical model; Machinery's Handbook, 25th edition).

The model is a physical model developed in a way that most faithfully represents the parts of a system. Model may be full size or replicas made in the required (preferably standard) scale. Before the advent of computer 3D geometric modelling, physical models are made of clay, wood, foam or other materials.

The rapid development of computer modelling caused rapid preparation of prototypes and reduces the need for creation model physically, which relied on traditional techniques. This phenomenon is called “rapid prototyping” and represents a wide spectrum of operations, which are used to describe several related processes, relying on real models that are taken directly from 3D CAD data base. As defined above, this process can drastically reduce the time between the development of a concept model and making the projected work.

Geometric modelling is a set of processes of complex ideas, products or processes, using drawings or computer models instead of conventional in design process. The final drawings, received using this method were created as 2D and 3D schemes or models. Two-dimensional schemes are very useful for some engineering analysis, such as kinematic, and check the position of circuit elements, wiring diagrams and check the blueprints, schematic view of some components and structural plans.

Three-dimensional models are created in the CAD system may be in the form of a “wireframe” model, surface or solid models. “Wireframe” models are used as input geometry data for easy analysis of the work, such as various kinematic studies and finite element analysis. Surface models are used in visualization; automatically remove hidden lines and animation. Solid models are used for analysis and visualization of the mall together with engineering and math, and they are most precise product descriptions and facilities.

8. 3D modelling

Traditionally, communication between engineers was performed through drawings, which can be in any of the aforementioned forms (sketch, drawing, physical model). In recent years, caused by a rapid technological development in the field of computer technology, 3D solid models have become available in all forms of communication engineering and take a leading role in all aspects of engineering. There are two basic approaches to generating 3D solid model:

- Wireframe model.
- Surface model.

The simplest form of the formation of the 3D modeller is wireframe modeller. In this type of modeller, use the two elements that must be defined essentially: edges and vertices (**Figure 9**). For the tetrahedron, shown in **Figure 5**, the vertex list contains geometric data.

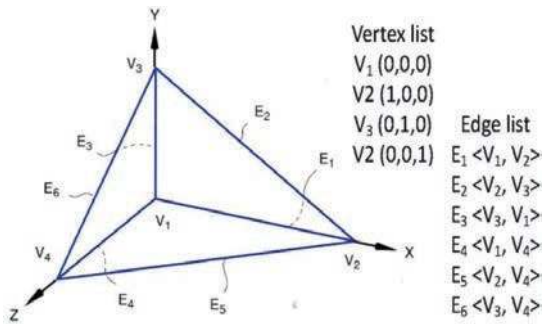

Figure 9. Wireframe model.

Wireframe model may also contain information on planes, such as the size of the location and orientation just as the edge defined by the vertices coordinates, levels are defined by three or more edges. However, all this information is related only to a set of edges. There is no possibility to join the space between them.

During modelling, wireframe model, in most cases, should include a combination of curves and straight edges (Figure 10). In this case, they display “wireframe” model of the cylinder. Complete circuit base is split into two arcs; it would be possible to connect it with the rest of the edges.

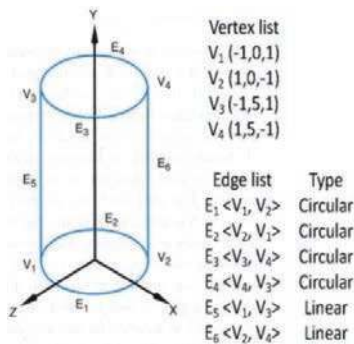

Figure 10. A wireframe model using circular and linear.

Wireframe model may have a problem of uniqueness. Figure 11 shows an example of different solutions, respectively, different realistic looking surfaces with a unique wireframe model. Because surface information is not available, edges that would normally be hidden are not, and the orientation is unclear. Some wireframe models have implemented computation routines to calculate and remove hidden edges. Since this involves calculating surface infor-

mation that is not inherent in a true wireframe modeller, the process is often slow and cumbersome.

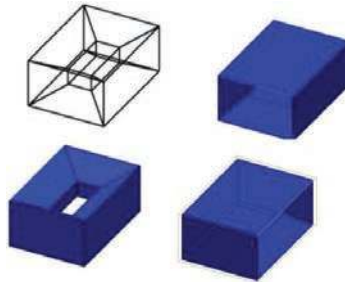

Figure 11. Lacking wireframe model.

Surface model defines both the characteristics of the surface and edges of a geometric object. Surfaces can be formed using several different techniques. Some of the most popular techniques are as follows: buckling, reversal and creating compounds ripple limit curves or sets of points (clouds of points).

Sweeping is a modelling technique in which the surface is obtained by movement Directrix through Generatrix (Figure 12). Directrix is a typical 2D line, while generating can be a line, curve or 3D planar fault.

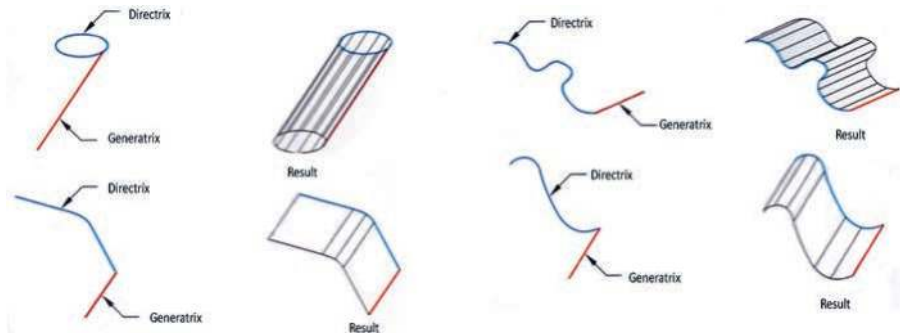

Figure 12. Swept surfaces.

This technique can be obtained for receiving complexes surfaces. Figure 13 shows a Directrix curve being swept out along a curve Generatrix to create a surface model. An alternative to this technique is that the Directrix directly rotates around its axis. In this case, performs the function of axis Generatrices. Figure 14 shows a classic example of the surface obtained by rotation. In this case, the axis of revolution acts as the Generatrix. It is shown a classic revolved

surface, a half circle revolved 360° to form a sphere. More complex forms can be created using techniques such as placing the axis of revolution so it does not touch the Directrix, using complex curve as a Directrix, and revolving less than 360° .

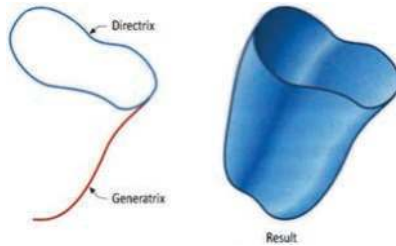

Figure 13. Complex surface.

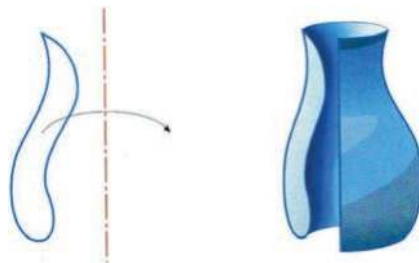

Figure 14. Revolved surface.

Using multiple Directrix to define multiple intermediate point, it can form even more complex surface. This technique, lofting, allows define critical changes in the shape in the Directrix along the vertex. Directrix is arranged in parallel or helically relative to one another within the required distance (Figure 15).

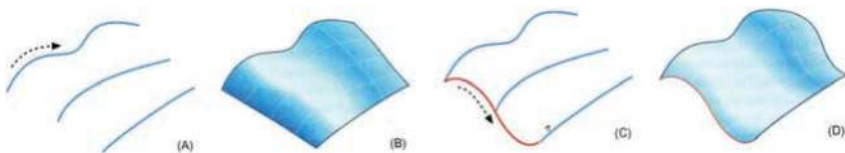

Figure 15. Lofting to define a surface.

It is also possible to use a freedom curves as regularly to create a surface patches from boundary curves.

9. Methods of computer graphics simulation, animation, and analysis of virtual 3D models

Computer simulation is a set of very precise modelled real situations that affect the technical systems in real time. Three-dimensional computer model can be used instead of physical to perform the necessary analysis. **Figure 16** shows the simulation of the heat exchanger. Regardless of the aesthetic moment, this analysis provides a very clear picture of the quality of the proposed design and its functionality. According to the colour palette, constructor can check their preliminary design directly to correct it, if necessary. This process does not require a large work time, and it can be repeated in a large-required number of iterations until a satisfactory solution. Simulations have substantively role in scientific studies of certain technical systems. They are very useful in a variety of presentations.

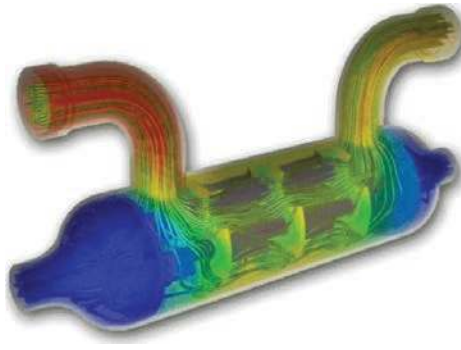

Figure 16. Simulation of the heat exchanger [1].

Computer animation is to show the behaviour of a system in real time. The difference between animation and simulation in the degree of precision of the results obtained, animation describes examination about the situation, while the simulation accurately describes. A lot of technical systems contain mechanisms with moving elements. The movement is achieved by moving the geometric space of time. These are very important elements of technical analysis of the design of the system. For visualization of the technical system's geometry is what it shows. For the mechanism, together with the movement must be displayed and the time dimension. One way to view the movement mechanism is to present several images of movement of technical systems in different time intervals. Using computer, time interval is easier to show and motion picture series fits into animation. The quality of the animation depends on the number of images (frames) in a time interval. The value of 15 frames per second gives the effect of the apparent movement of the body seems to be really moving. Combined with other items, such as the removal of invisible lines and shading, animation helps to clarify the shape and form of the building. In the event of a change of location and orientation of the animation, it shows successful change of geometry and shapes, such as deformation caused

by the action of another object or removing material. Animation gives possibility to record changes and other more abstract data, not just the geometry.

Analysis of the design is the evaluation of the proposed design, based on the criteria established in the phase of creating the conceptual design. This is the second major step in the design process of the final product, and the entire design team is involved in it. Typical analyses are carried out during the design process are as follows:

- Structural analysis, which assesses the design basis of physical properties, such as strength, size, volume and centre of gravity, weight, and centre of rotation, as well as its thermal, fluid and mechanical properties.
- Mechanical analysis of the mechanisms dealing with the movement of the loads that can occur in the mechanical systems of rigid bodies-related joints.
- Functional analysis, which determines whether the proposed design for the way in which it is provided or whether the design performs and fulfil the requirements specified in the stage setting of the problem.
- Analysis of human factors (ergonomic analysis), which assesses the design to determine whether the product is used in physical, emotional, qualitative, mental and security needs of consumers.
- Aesthetic analysis, which assesses the design basis of its aesthetic qualities.
- Market analysis, which determines whether the design meets the needs of consumers, based on the results of surveys or focus groups.
- Financial analysis, which determines whether the price of the proposed designs to be projected range price range provided for in the idea stage.

Structural analysis is largely based on the analysis of the finite elements. Its task is to confirm the safety and longevity of use of the system. Models are tested in extreme conditions, and the information obtained is used to improve the technical solutions. **Figure 17** shows an example of structural analysis when designing presses for bending pipes. In this case, the analysis was performed voltage and deformations presses for bending during the process of exploitation. A large number of information helps the user to make a calculation of the forces acting on an object, but it is very difficult to determine how the building reacts to them. The virtual 3D model is designed so that it has the same thermal and elastic characteristics as the material of which will be made real product. Instead of the real load of articles model is load hypothetically using virtual 3D models and get the critical results of a physical prototype. Working with virtual model reduces the time of construction and production costs.

Mechanical analysis of the mechanisms dealing with the budget motion and loads of mechanical systems consisting of rigid bodies connected joints. One of most characteristic examples of such a system is a device for clamping. Mechanical analysis includes an analysis of a set of mechanisms, kinematic and dynamic analysis.

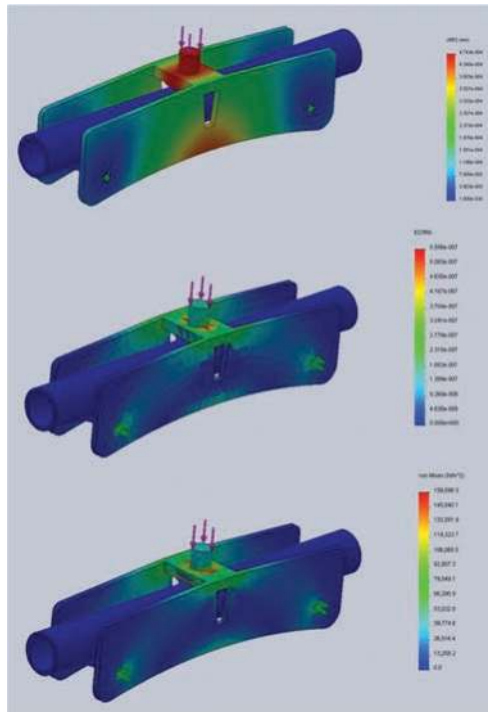

Figure 17. Analysis of presses for bending pipes [5].

Analysis of the core set is used to define the position of the individual solids and mechanism to verify correct installation, taking into account the geometry and speed of the circuit elements (**Figure 18**). When the computer 3D assembly dimensionally defined and assigned him the speed of the elements, the user types into a computer program complicated geometric and trigonometry relations.

Kinematic analysis is a technique used in the design of mechanisms, a set of several parts, which is run by defined legality. The mechanisms consist of two basic components: the body, which are associated levers and joints, which show that the leverage associated. The joint motion is carried, rotational, translational or a combination of the two. Connecting elements of the kinematic mechanism 3D model enables the designer to investigate fully and partially moving parts of the mechanism. This type of analysis also introduces a fourth dimension, time, 3D computer model. Time is determined by the orientation or location of a specific element of the mechanism in a certain period of time. The movement of parts of mechanisms can be shown transparently or by technique of moving with increasing “providence” display, and of course the animation. When this type of analysis, it is possible to check the geometry mechanisms so that there is no collision or overlapping elements. Although this analysis can be provided using

visual operations, Boolean's cross-section (see at various time intervals topology and geometry of any overlap during movement mechanism) provides a more precise estimate.

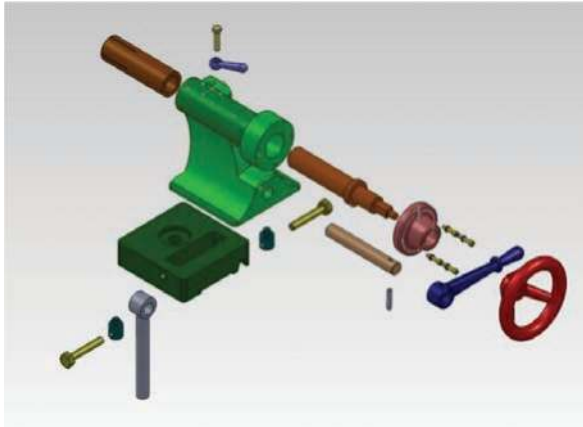

Figure 18. Assembly analysis [5].

Dynamic analysis is a sophisticated technique, which analyses the load under the influence of kinematic factors. Clean kinematic analysis predict that all parts moving at a constant speed, but without taking into account the forces acting on them. But the forces are acting on the mechanisms at any time. They are necessary in order to trigger a mechanism that would (due to friction) be continued to move. In these calculations, the most important role performed quality position of centres of mass of elements of the mechanism. This kind of analysis can be in the form of animation

Functional analysis is a process in which factors such as price, appearance, profitability, security, etc. had to take into consideration when determining the final design. Some factors are based on empirical evidence, such as testing for the ability to perform function, or as the fulfilment of the purposes for which it was designed.

Ergonomics represents a link between technology and man. It must include elements of comfort, efficiency and safety. It is possible to made 3D model products and man and to analyse their interaction. Some interactions are associated with the physical characteristics of the human body (Figure 19(a)), which are variable according to the value of personal characteristics. In the analyses, we use the mean value of the physical characteristics of the human population of a specific geographic region. Ergonomic analysis was performed in relation to the physical dimensions of the complete man. In Figure 19(b), it shows an example of ergonomic analysis. In the case of ergonomic analysis of 3D models, it can be manipulated, introduced mimicry, movement, etc. or to perform animation. Human limbs in these simulations can be treated as parts of the mechanism. Other elements of the virtual environment must be in accordance with human dimensions.

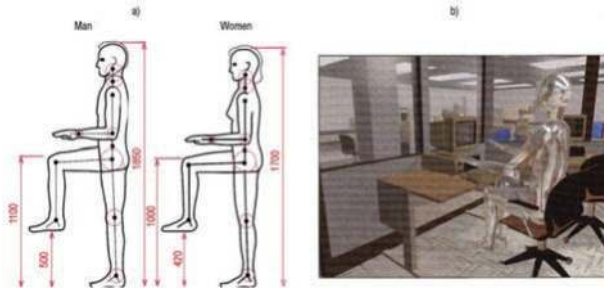

Figure 19. Ergonomic analysis.

10. Preparation of virtual 3D models of various technical systems methodology-formation model

Solid model is a set of volume and surface information from that form a 3D model. Most models can be described mathematically, using basic geometric shapes (Figure 20): a prism (with a specific case cube), pyramid, sphere, cone, torus (ring) and roller. Combining and subtracting these forms are obtained by more complicated models of different technical systems.

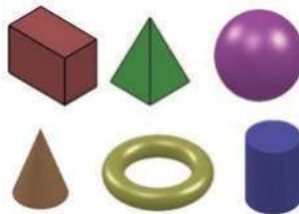

Figure 20. Basic geometric shapes [3].

To make virtual 3D model functioned properly in further analysis, it is necessary to properly form the initial elements of the model-assembly. Obviously, with the technical systems sets more elements, respectively, every technical system is a set of more technical parts. Each part of the system is formed as a separate 3D model, and these models assembled into a whole (alike a 3D assembly, but a single 3D model). It is essential that every part of the 3D model as this is established correctly. The safest, perhaps at first seemingly not easiest, method of forming a basic 3D model is to create a model of the basic geometric shape. Why statement “might at first not easiest”? In fact, almost two centuries, in engineering graphic communications was used planar, 2D, displaying technical elements and systems. The engineers and users have acquired the habit of such thinking, presentation and communication. It seems to be easier

based complicated contours add a third dimension (which is understandable for engineers who have long been forced to think in 2D where all contours were planar). Technological development of 3D models is possible to make direct, without making a 2D contour. The whole system of thinking is simplified, and the 3D models are formed using basic geometric shapes. In **Figure 21**, it shows an example of forming a shape of the camera (in this case was used only as a unique form of camera model (geometry was used for the formation of a technical element, is not treated as a technical circuit camera system)).

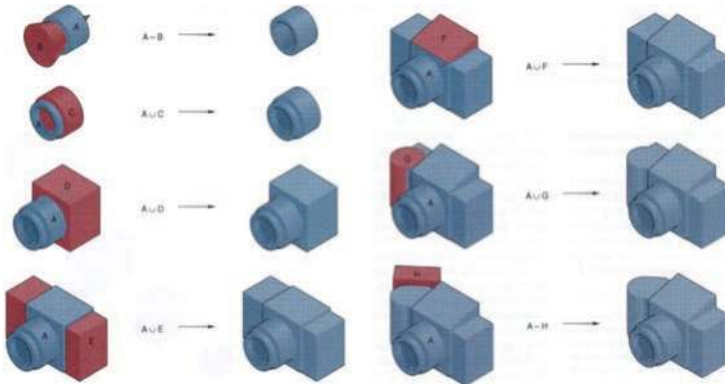

Figure 21. Making a complex 3D model form basic shapes [3].

11. Conclusion

The use of certain computer tools require manual dexterity and knowledge of these tools, however, during the formation of educational methodologies necessary to separate the time for familiarization with these issues. Each graphics software package has its own characteristics, but all are based on a similar graphic philosophy. The idea is that an educational methodology is adapted to the philosophy of preparing the model, while the graphic computer tools are just tools (such as is used in 2D drawing rulers, compasses, pencils, erasers, thin-lead ink pencils, drawing table, etc.), whose role is to a certain custom “facilitate” to the job designer. Using simple technical parts/system, it begins to user training. Of course, in all phases of technical design freehand sketch system, it has its own role. This is one technique that is available to each user, and at any time. I do not see the moment in the future when the need to stop using the freehand drawings in engineering graphic communications. She has always had an important role in this field and will always have it, regardless of the technological advances.

The next level in educational methodology is based on dimensional defining characteristic of technical work/system. At this stage, it is determining the precise geometric characteristics of

the model, corresponding to the initial requirements. Some parts/systems have complicated geometric characteristics, so the modelling process is carried out in several phases. At this level introduces, the initial formation of the technical documentation, as there is enough data for the formation of technical drawings. It is necessary to note that the production of technical drawings on the level of economic development in our country (this is the specificity of the site and the technological development at the state level) is still necessary. Tendencies are to be improved and production of computer-controlled machines to produce technical elements/systems directly with 3D computer models. This is conditioned by economic factors.

By creating precise elements of the system, it is possible to form the whole system. We are entering a phase of assembling component parts into a 3D system, the formation of the necessary documentation. In subsequent stages, it can be made of the analysis formed the system (which cannot be made on the entry level engineering knowledge, but users who already have mastered engineering skills are fully capable of performing the necessary analysis).

The next element of the educational model is based on reversible engineering. This is the one element that is required for each user: recording real technical elements/systems and data for further design and analysis. At this stage, the users are trained and that the data transmitted from technical drawings to the formation of the 3D model.

Finally, education in the field of technical graphic communication comes to the stage of the formation of the entire technical elements/systems, to the coverage of all phases.

Acknowledgements

This work was financially supported by the Ministry of Science and Technological Development of the Republic of Serbia through Project No. TR 35011.

Author details

Zorana Jeli*, Branislav Popokostantinovic and Misa Stojicevic

*Address all correspondence to: zjeli@mas.bg.ac.rs

Faculty of Mechanical Engineering, Belgrade University, Belgrade, Serbia

References

- [1] Barr R.E., Krueger T.J., Juricic D., Aanstoos T.A.: Engineering Design, Graphics Sketching Workbook, 5th edn, Schroff Development Corporation, Mission, KS, 2004.

- [2] Barr R.E., Juricic D., Krueger T.J., Wood B.H: Engineering Design Graphics Workbook, A Concurrent Engineering Approach, Schroff Development Corporation, Mission, KS, 1997.
- [3] Bertoline G.R., Wiebe E.N.: Fundaments of Graphics Communication, The McGraw-Hill Graphics Series, 2007.
- [4] Bertoline G.R., Wiebe E.N., Miller C., Nasman L.: Engineering Graphics Communication, Irvin Graphics Series, 1995.
- [5] Jeli Z.: Graphics Communications and Virtual Reality in Development of Technical Systems, Ph.D. Dissertation, Belgrade, 2012.

